

Nevoga®

FORM COLLECTION

F21

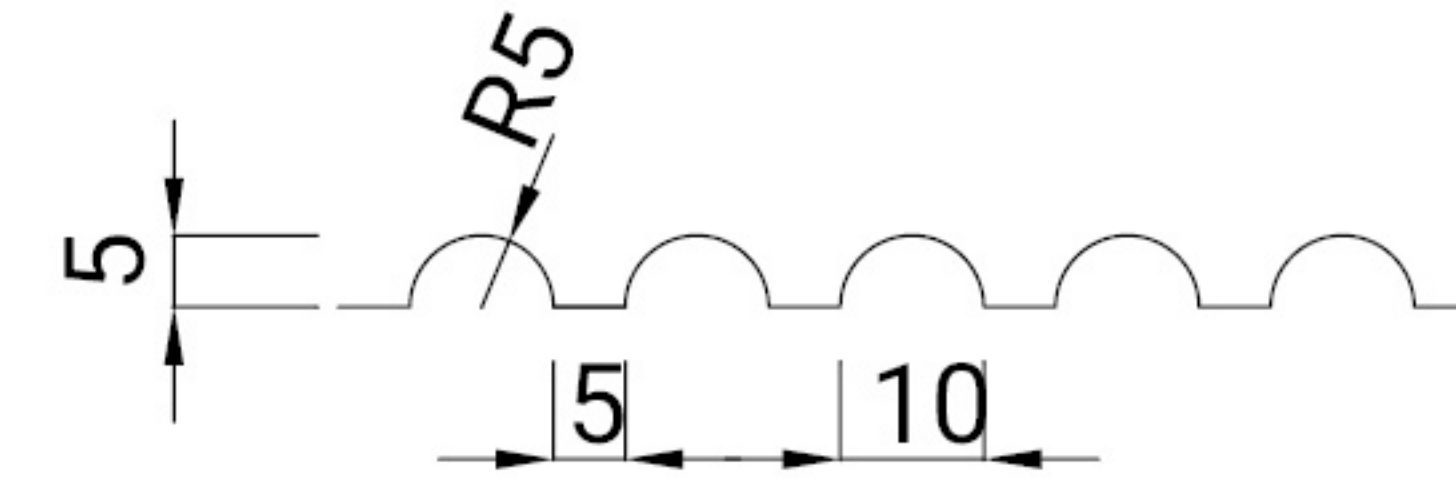
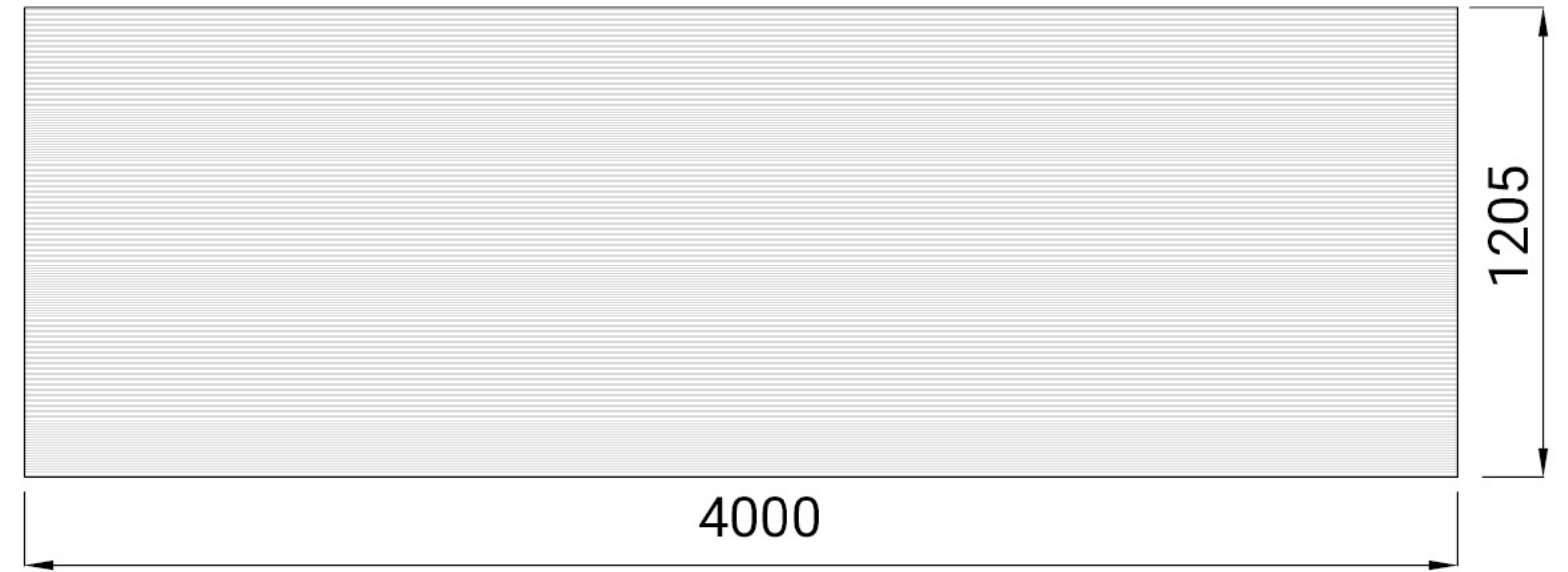

Nevoga®

FORM COLLECTION

F22

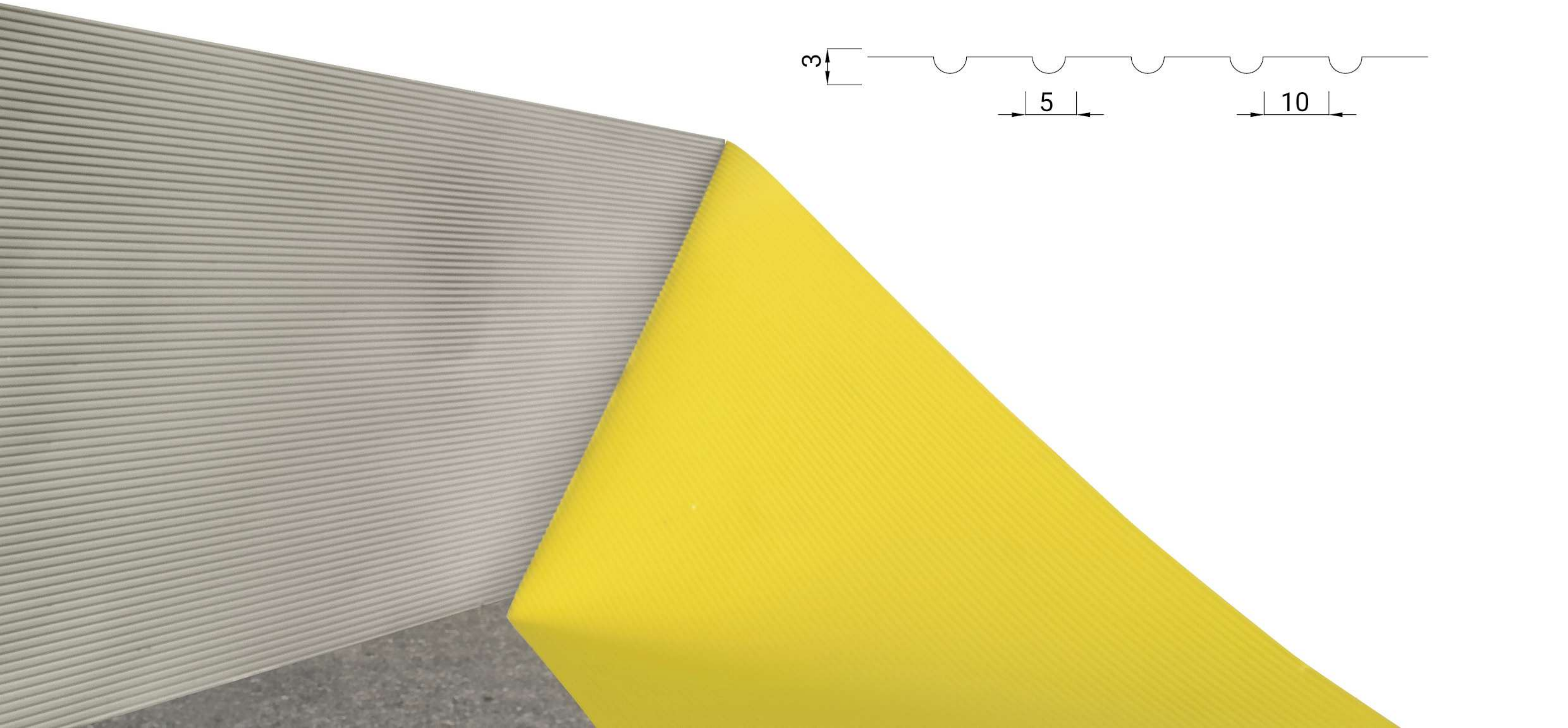
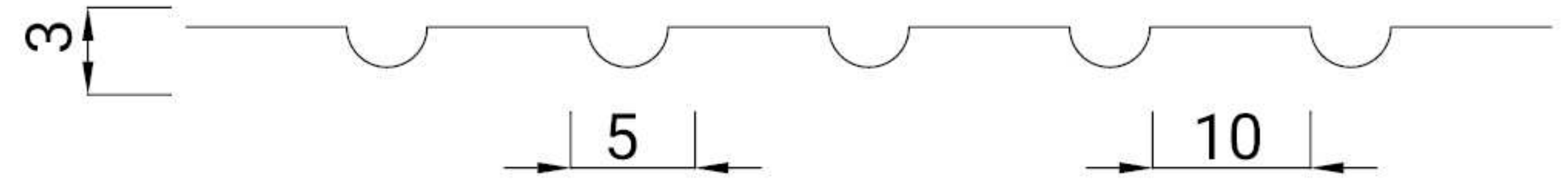
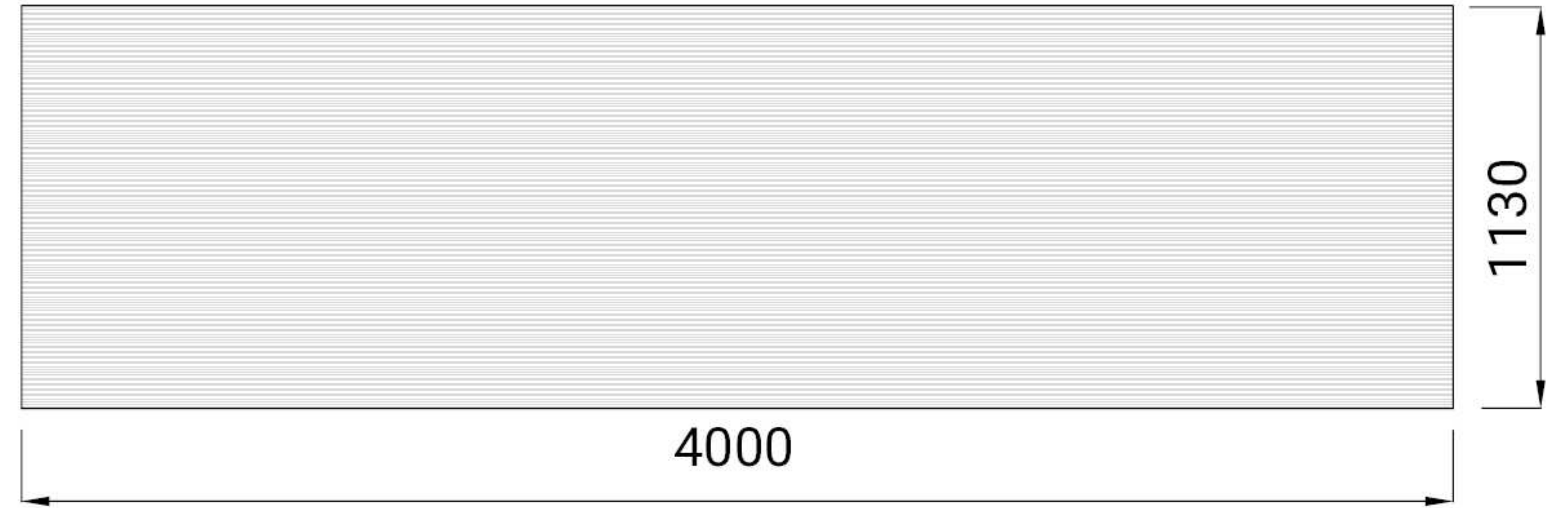

Nevoga®

FORM COLLECTION

F23

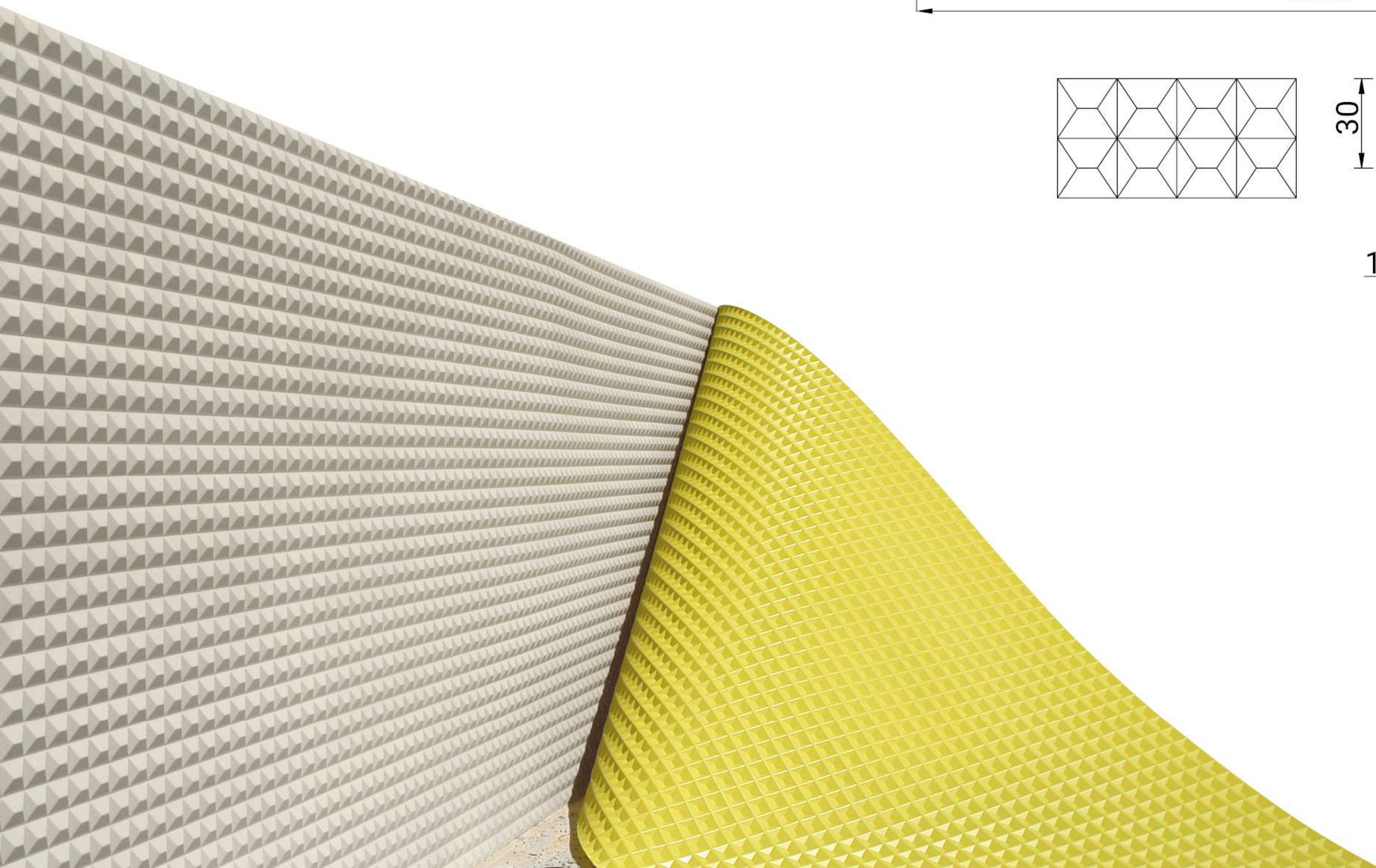
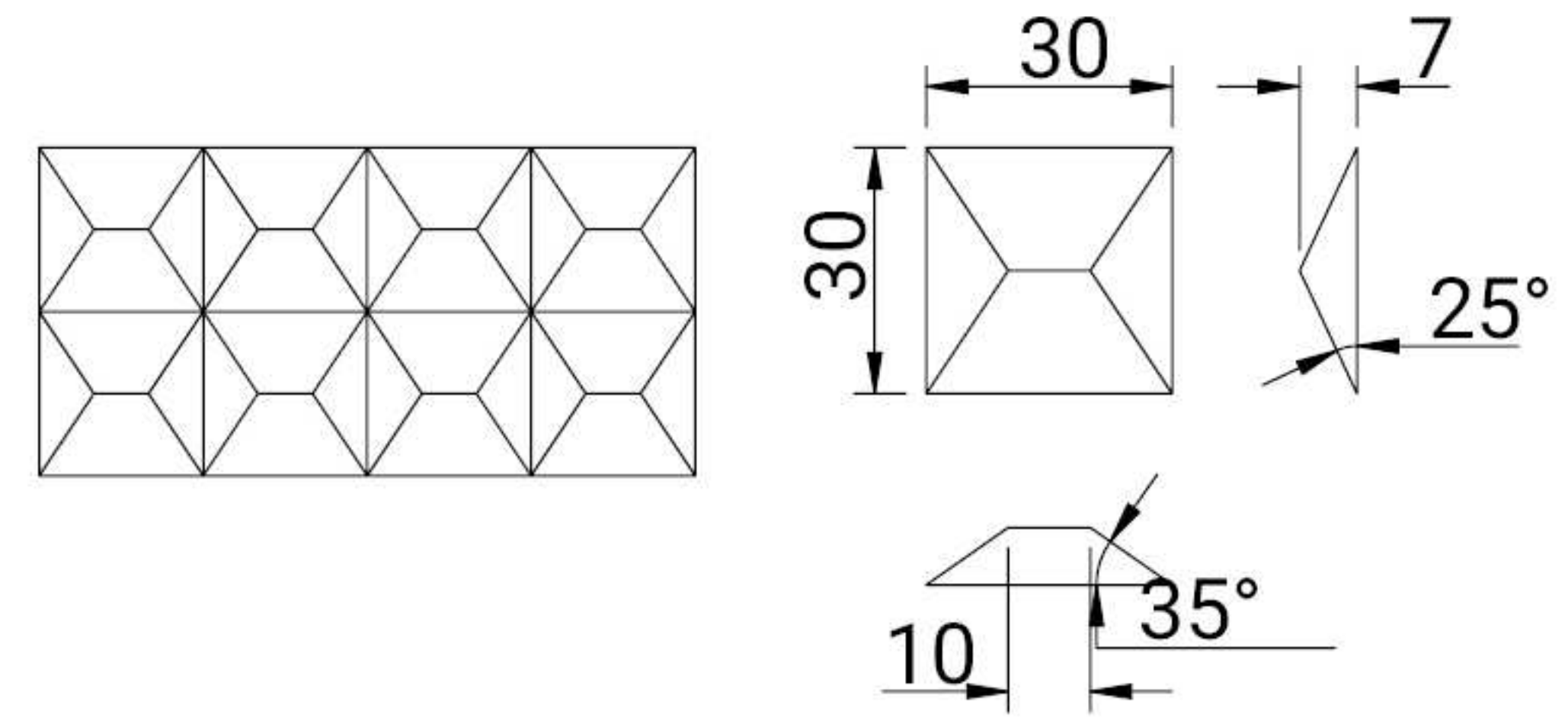
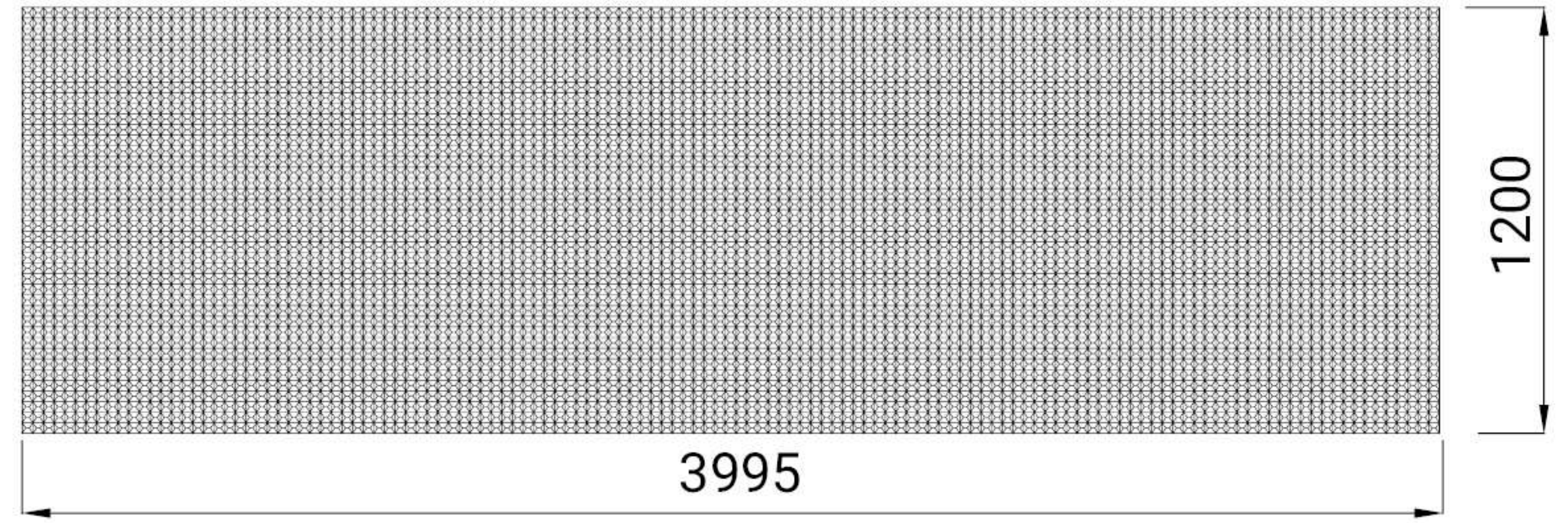

Nevoga®

FORM COLLECTION

F28

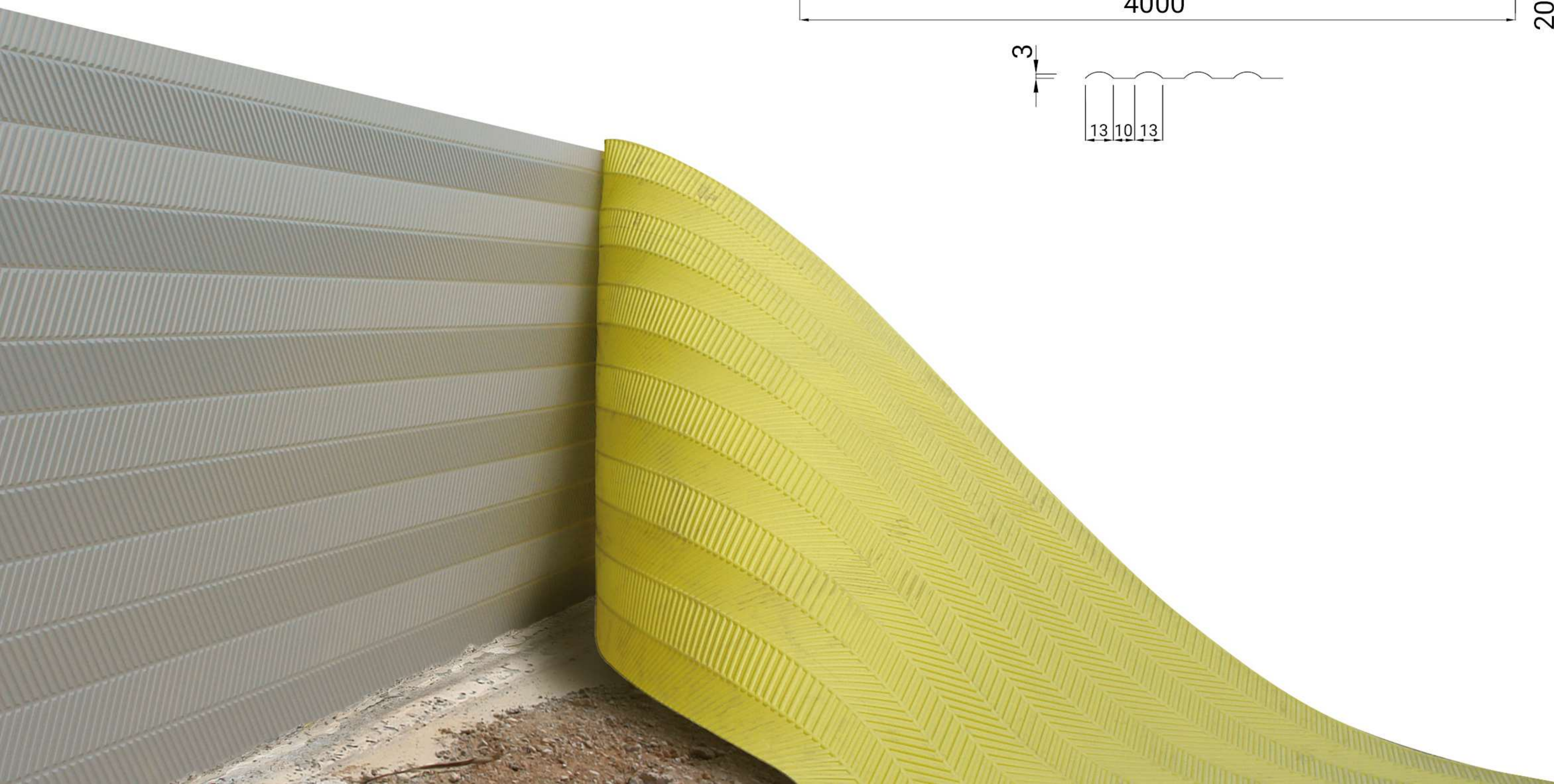
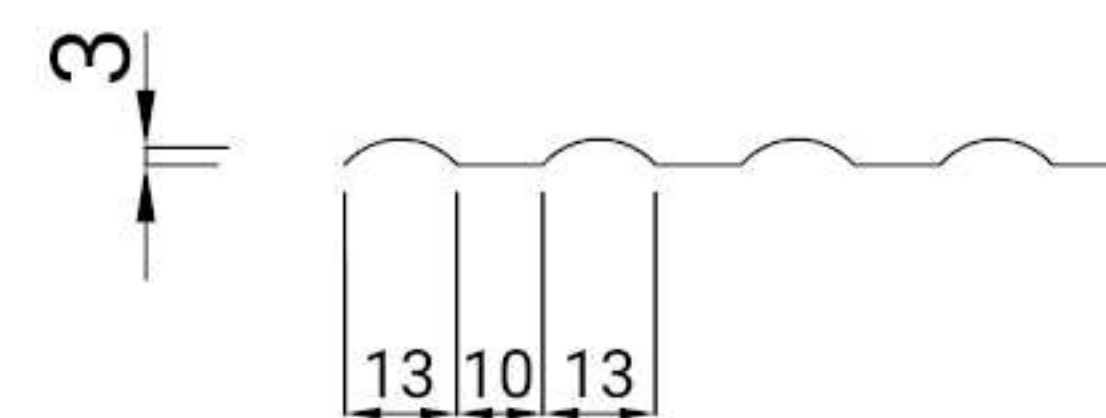
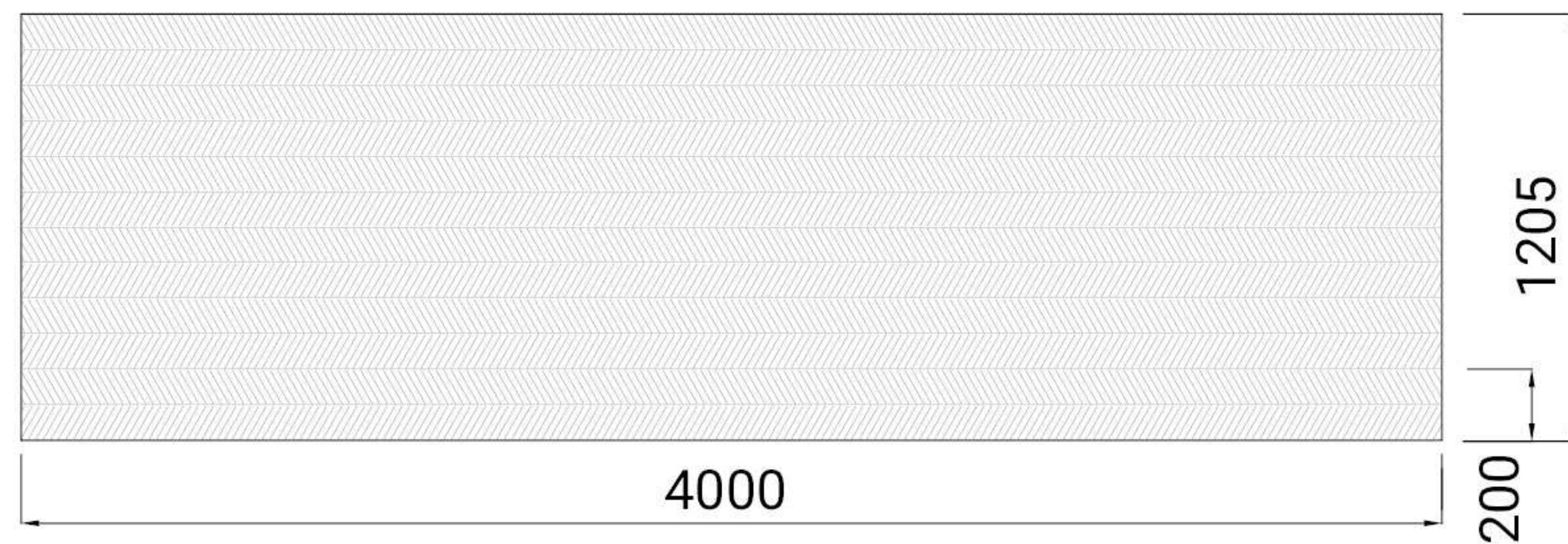

Nevoga[®]

FORM COLLECTION

F29

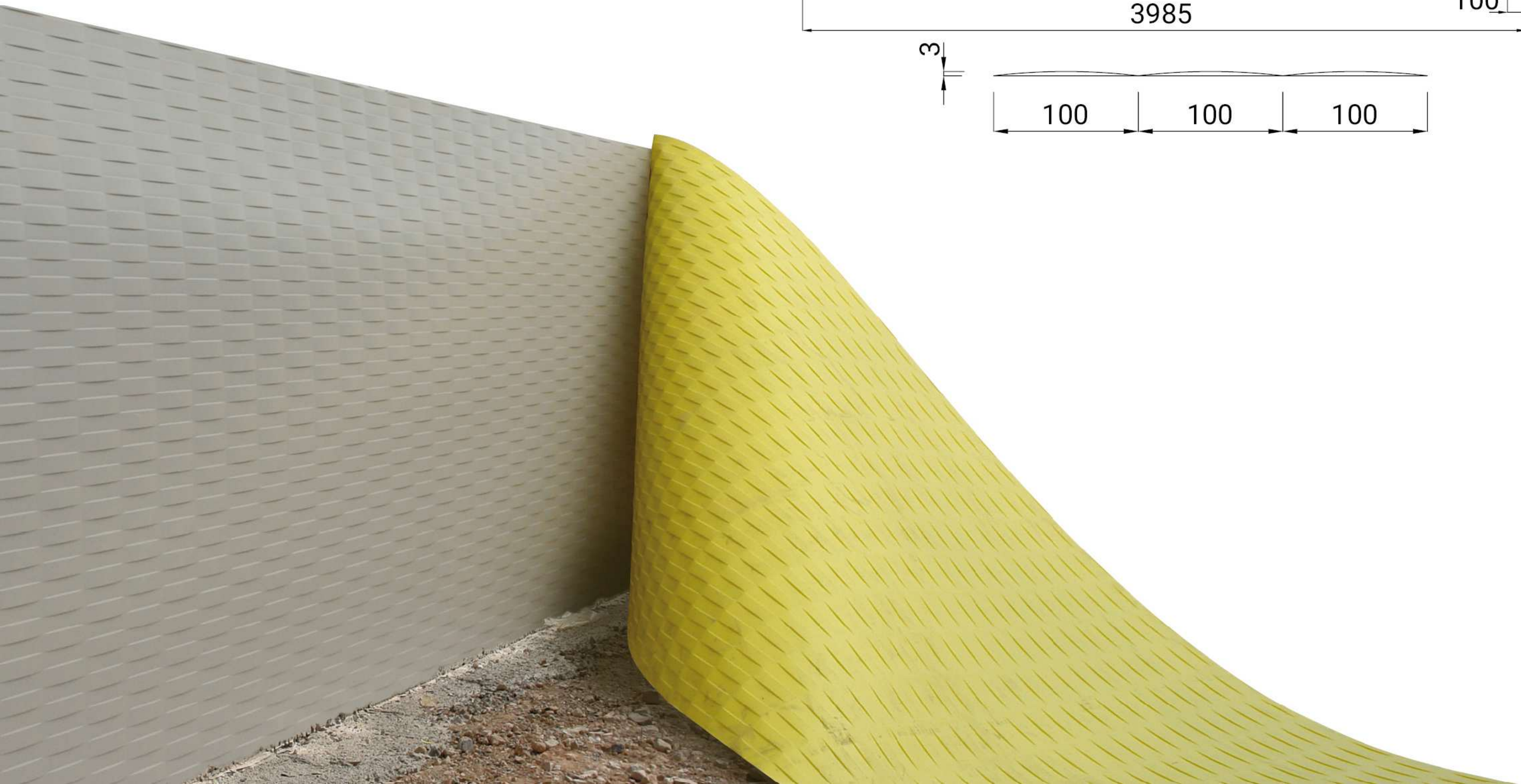
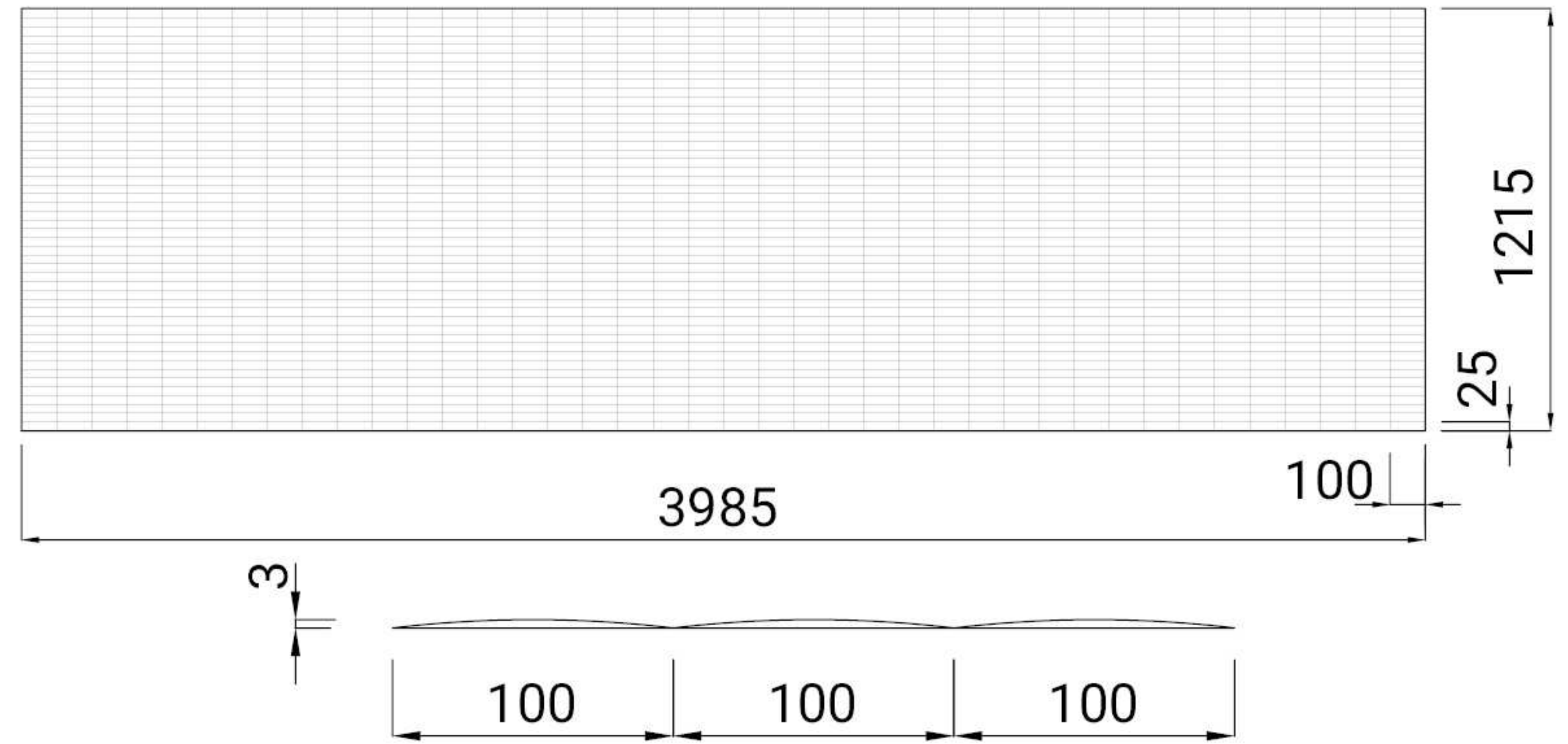

Nevoga®

FORM COLLECTION

F30

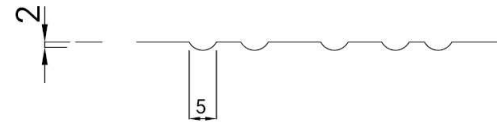
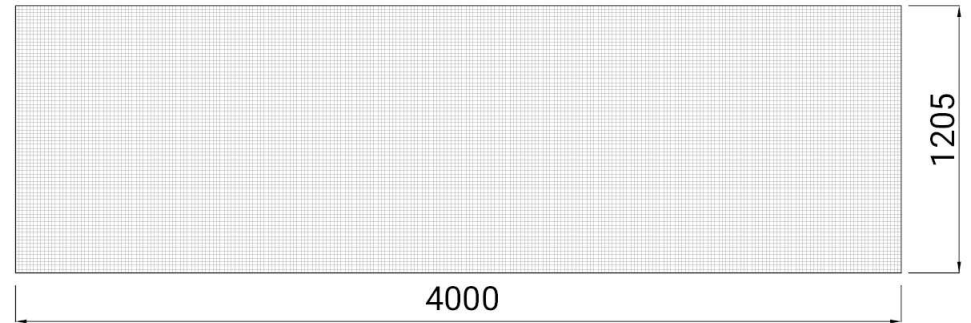

Nevoga®

FORM COLLECTION

F31

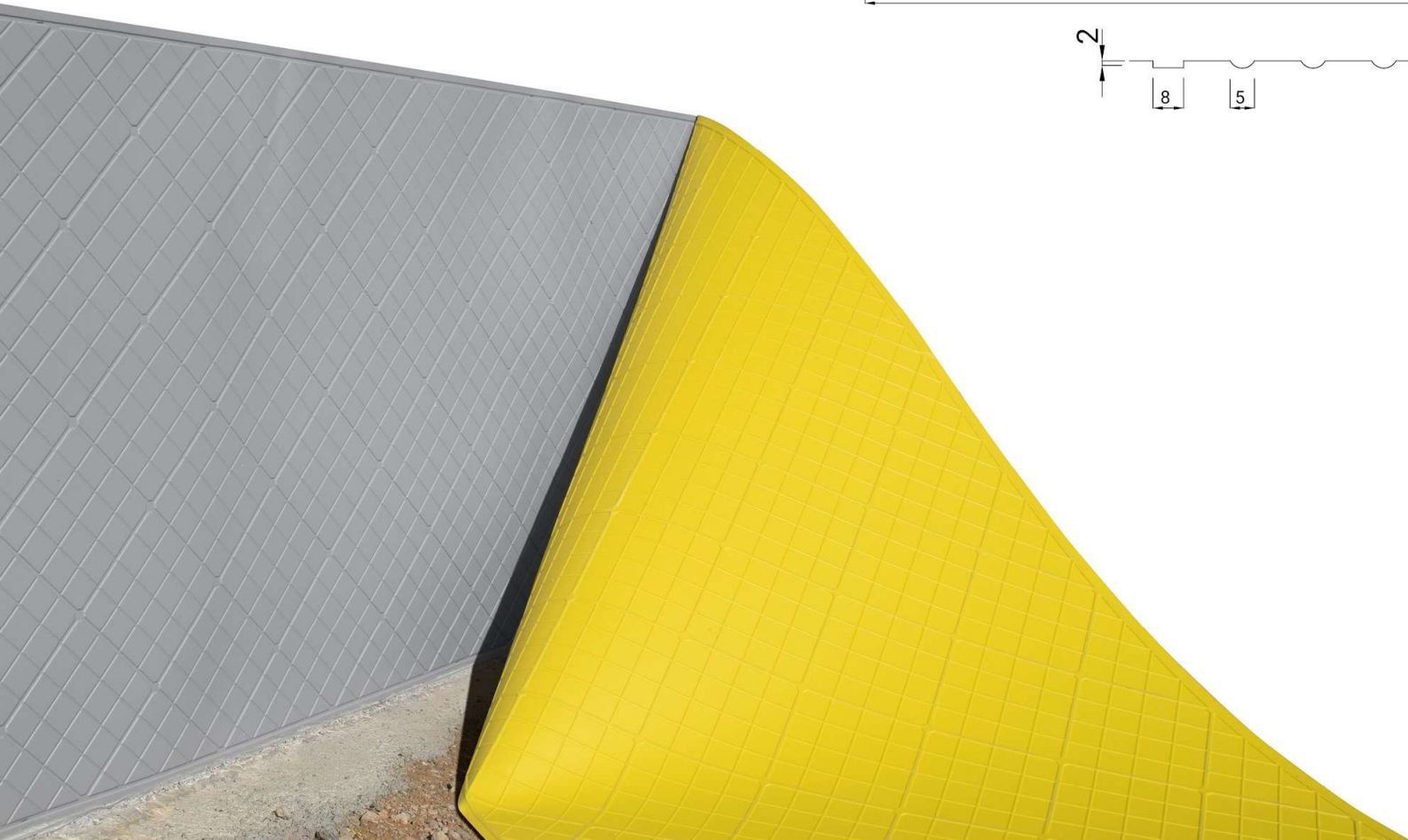
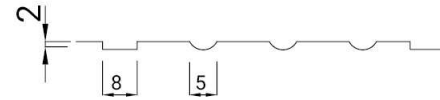
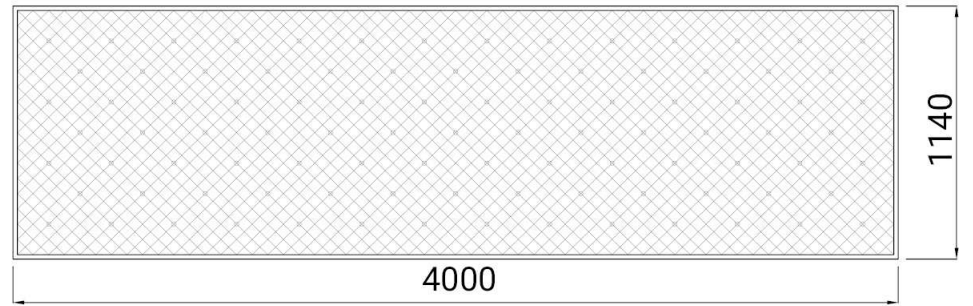

Nevoga®

FORM COLLECTION

F32

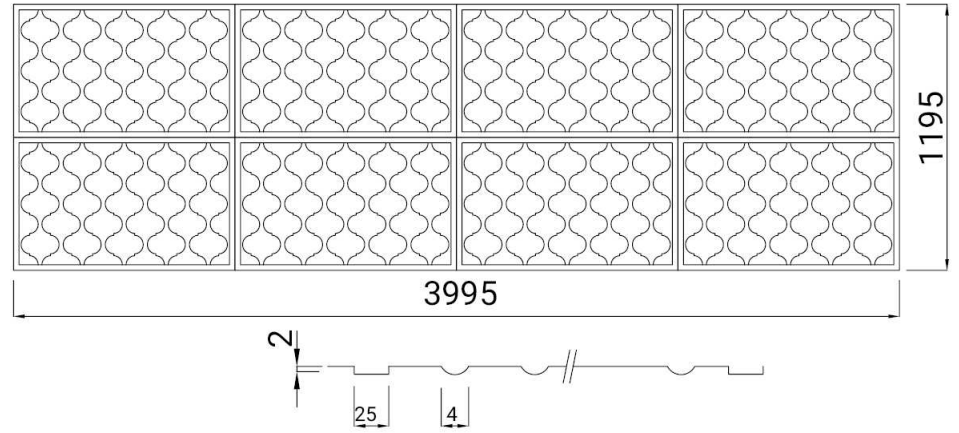

Nevoga®

FORM COLLECTION

F33

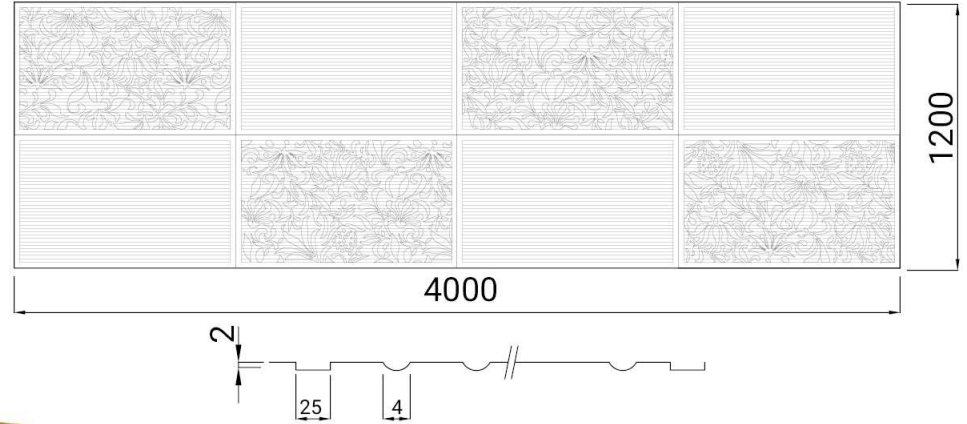

Nevoga®

FORM COLLECTION

F34

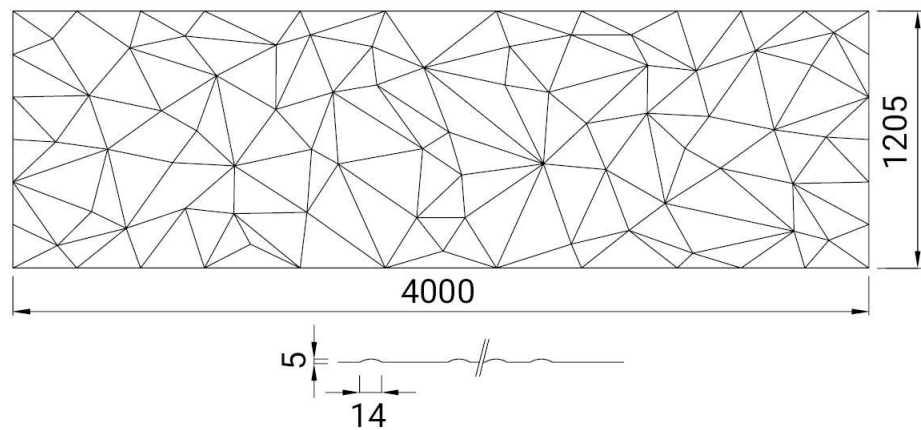

Nevoga®

FORM COLLECTION

F66

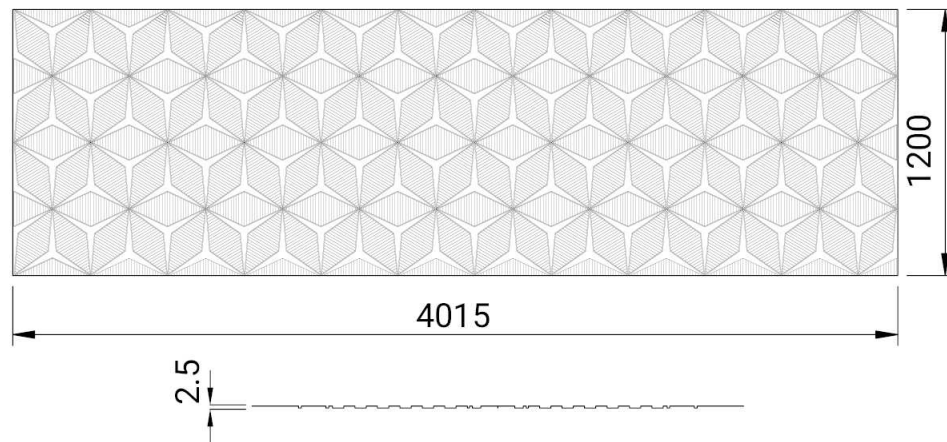
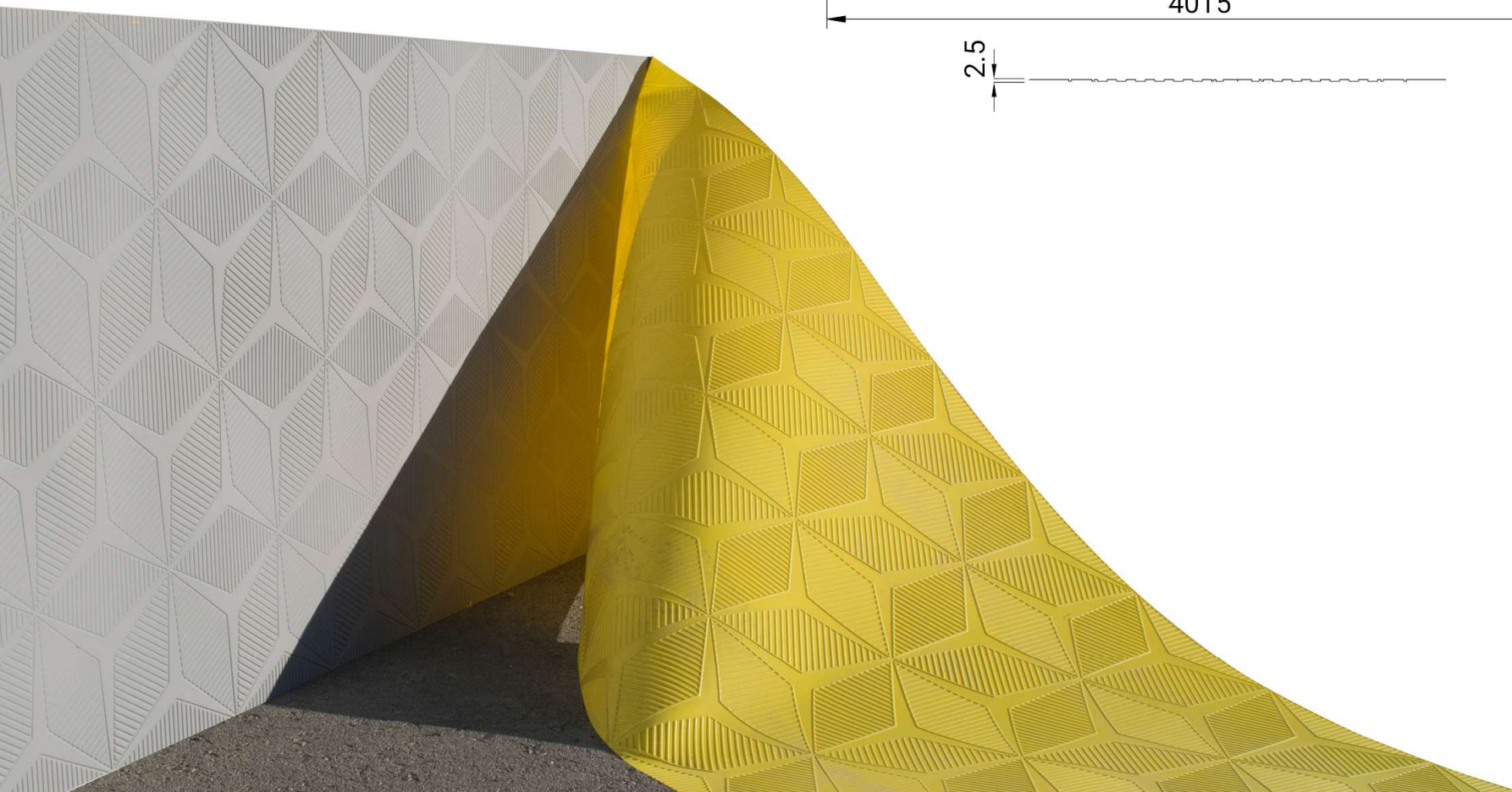

Nevoga®

FORM COLLECTION

F75

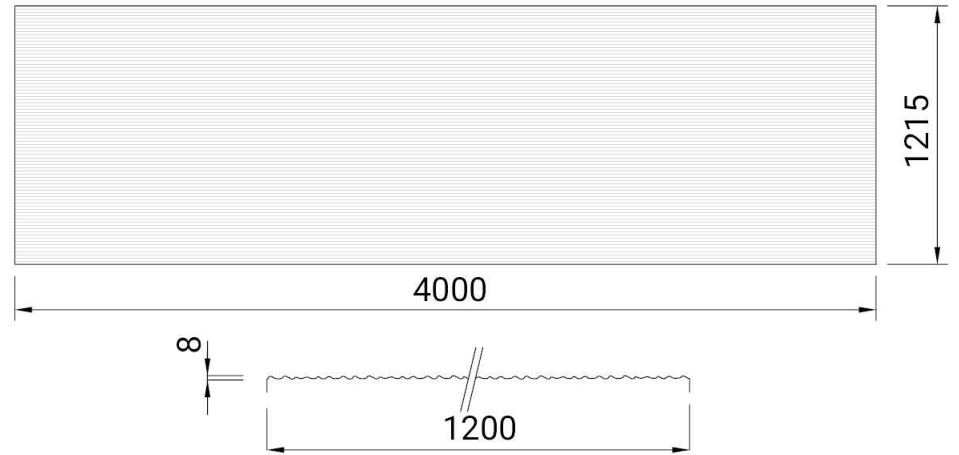
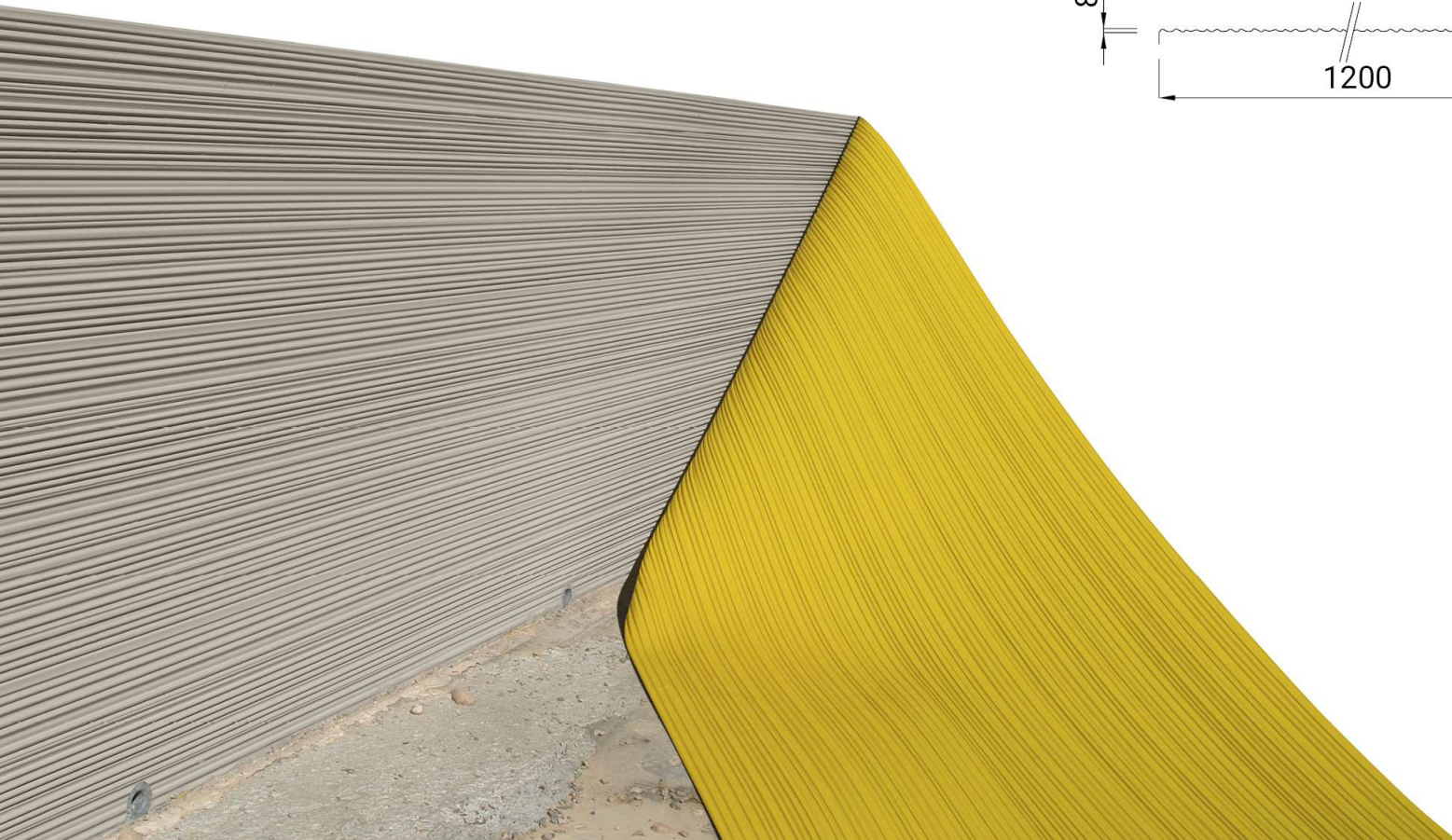

Nevoga®

FORM COLLECTION

F77

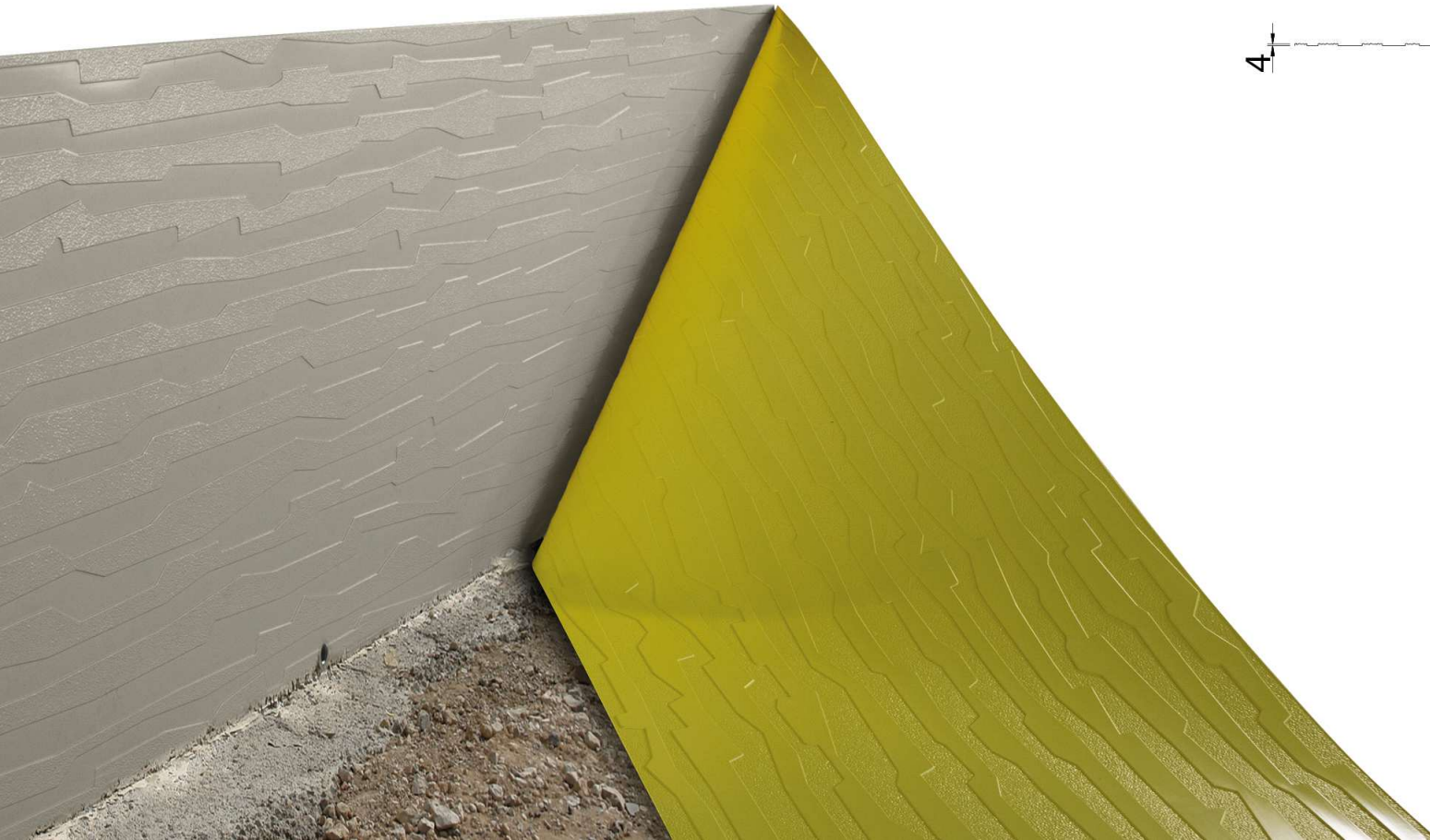
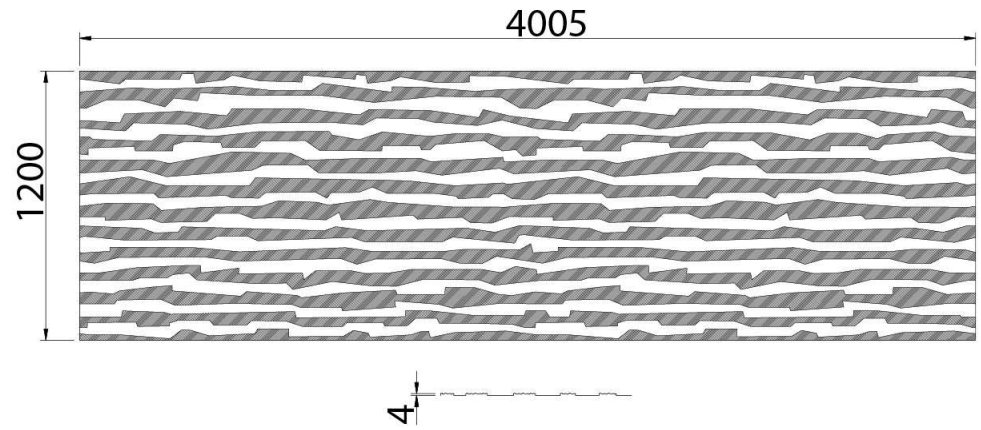

Nevoga®

FORM COLLECTION

F78

